

Наличие картинок.

В начале слова – прямой слог:

- шаг, шайба, шакал, шалун, шапка, шар, шарф, шах, шахматы,
- шило, шимпанзе, шина, шинель, шипит, шиповник, шипы, ширма, широкая, шить,
- шелуха, шеф, шея,
- шёл, шёлк, шёпот, шов, шоколад, шомпол, шорох, шорты,
- шуба, шум, шумит, шумовка, шуруп, шут, шутит,

В начале слов – в стечении согласных:

- швабра, швы, шкатулка, шкаф, школьники, шкурить, шкура,
- шланг, шлем, шлемофон, шлёпанцы, шлюпка, шляпа,
- шмели, шнурок,
- шпага, шпагат, шпалы, шпатель, шпильки, шпоры, шприц, шпулька,
- штаны, штанга, штора, штурвал,

В середине слова – прямой слог:

- вешалка, груша, крыша, лошадь, слушает, хорошая, шалаши, кушетка, мешок,
- камыши, карандаши, кашалот, ковшик, кувшин, ландыши, мыши, уши,
швейная машина,
- гребешок, горшок, петушок,
- кошелёк, мишень, ошейник, торшер, пшеница
- парашют,

В конце слова – обратный слог:

- брошь, детёныш, душ, карандаш, ландыш, малыш, манеж, нож, рожь, уж, шалаш,

В середине слова – обратный слог:

- бабушка, башня, вишни, вышка, дедушка, игрушки, катушка, каштан, кокошник, кошка, кукушка, лукошко, матрёшка, мешки, мишка, мышка, неваляшка, окошко, пушка, подушка, пышка, шашки, шишка,



. аг



. ар



. ах



. арф



. айба

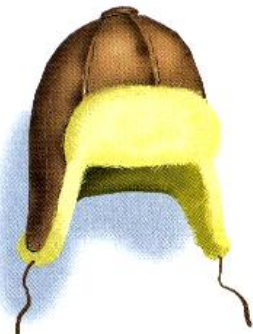

. апка



. ахматы



. алун



. акал



. уба



. ум



. ут



. утка



. УМИТ

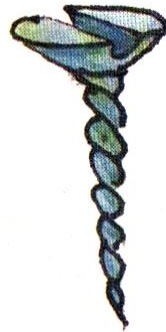

. уруп



. УМОВКА



. ИТЬ



. ина



. ИПЫ



. ИЛО

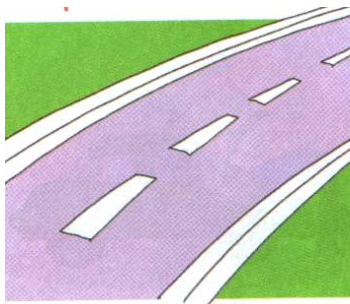

. ирокая

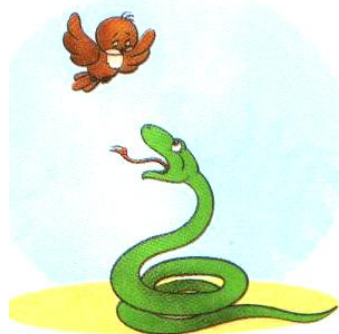

. ИПИТ



. ИПОВНИК

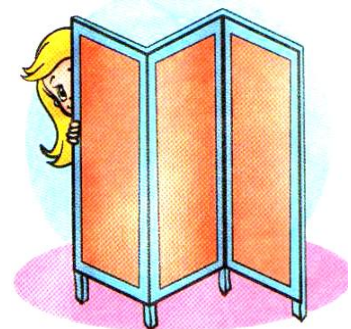

. ирма



. ИМПАНЗЕ



. ИНЕЛЬ

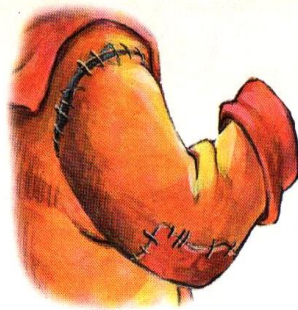

. ОВ



. ЁЛ



. ЁЛК



. ОПОТ



. ОРОХ



. ОРТЫ

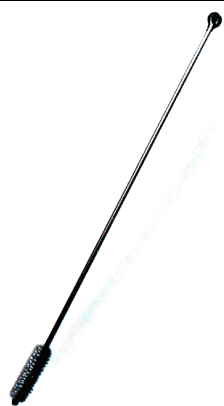

. ОМПОЛ



. ЕФ



. ЕЯ

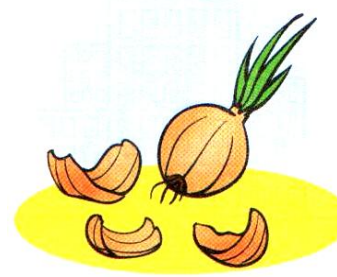

. ЕЛУХА



. ОКОЛАД



. ЬЁТ



. ВАБРА



. ВЫ

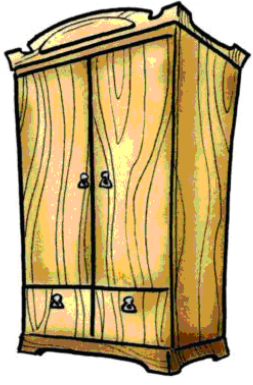

. каф

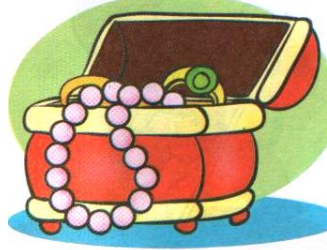

. катулка



. курит



. КОЛЬНИКИ



. кура

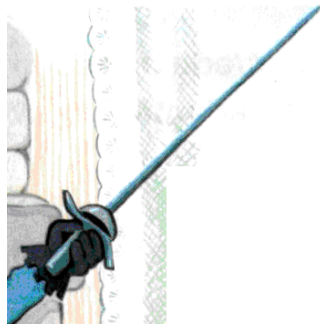

. пага



. поры



. пагат



. таны



. приц

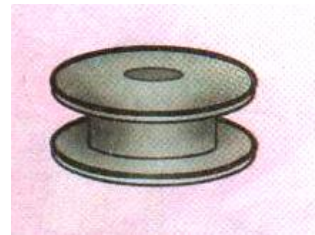

. пулька



. патель



. ПИЛЬКИ

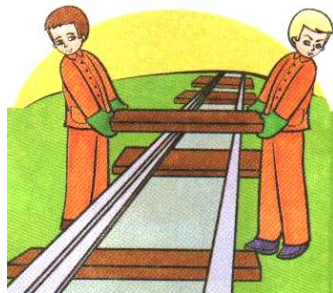

. палы

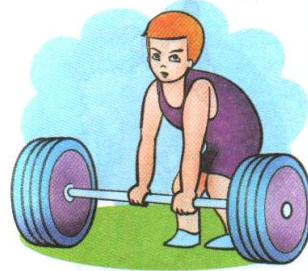

. танга



. лем

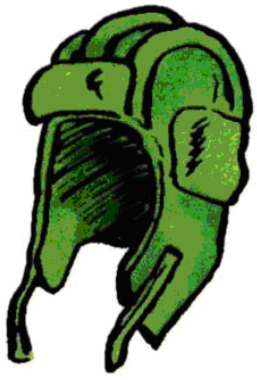

. лемофон



. лёпанцы

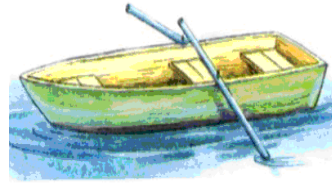

. люпка



. ляпа



. мели

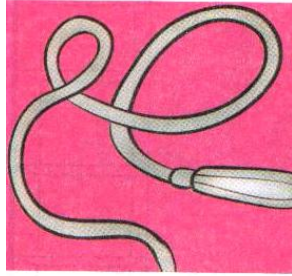

. ланг



. тора

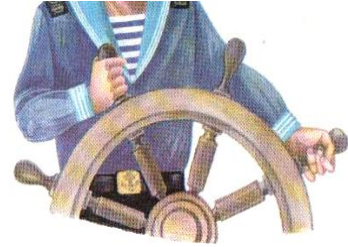

. турвал



ло . адъ



хоро . ая



ков . ик



шала . и



ланды . и

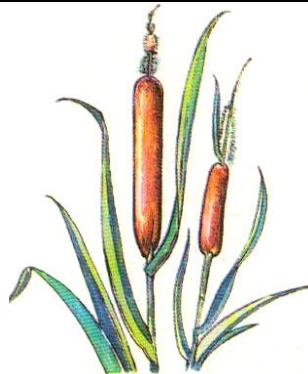

камы . и



кув . н

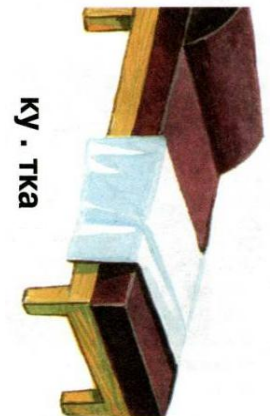

ку . тка



ме . к



мы . и



у . .

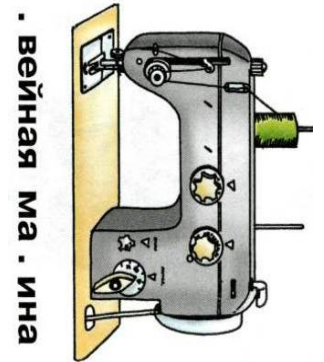

швейная машина

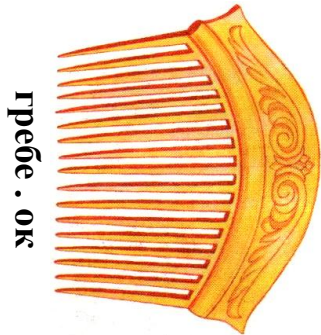

гребень . ок

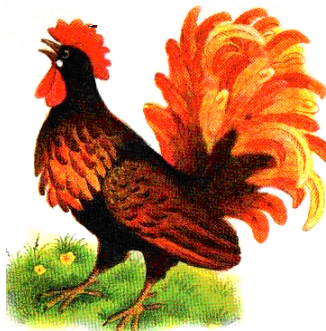

петух . ок

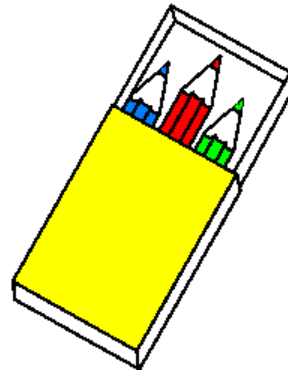

карандаш . и



парашют

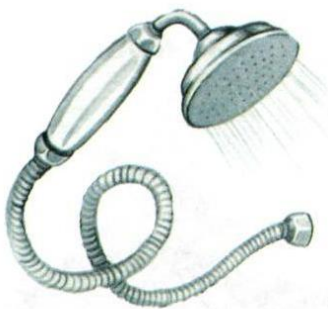

душ .



карандаш .



брошь .

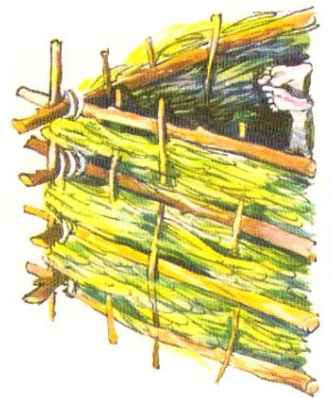

сено .



рожь .

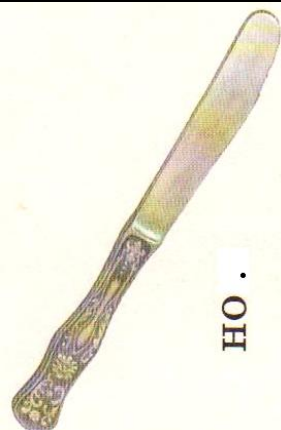

нож .



листья .

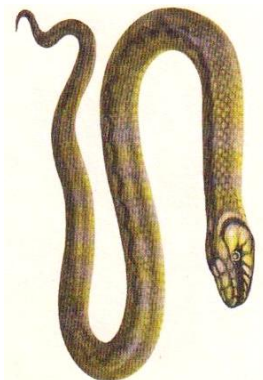

змея .



ма . лы .



де . т ё ны .



не . ва . ля . ка



де . ду . ка



ба . бу . ка



ка . та . ны



пу . ка

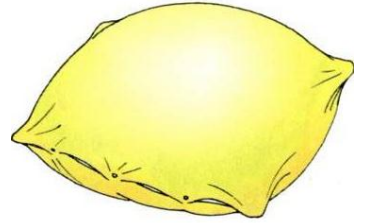

по . ду . ка



ка . ту . ка

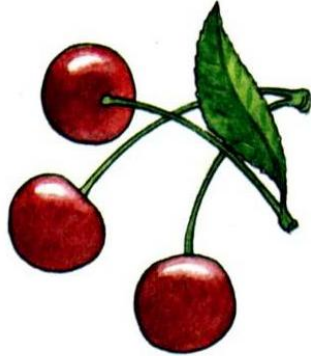

ви . ни

мы . ка



ко . ка

ку . ку . ка



ба . ня

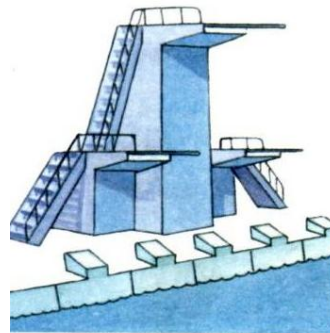

вы . ка

. а . ки

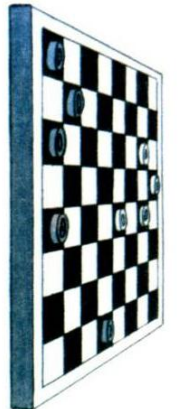



. и . ка



луко . ко



матрё . ка

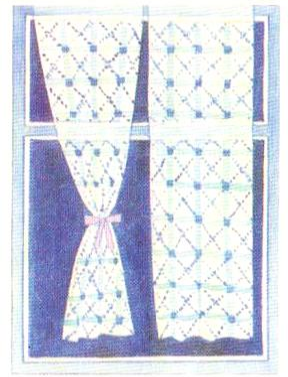

око . ко



пы . ка



ми . ень



тор . ер



ко . елёк

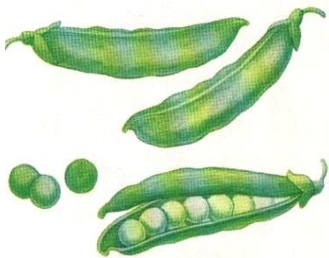

горо . ек



гор . ок



ве . алка

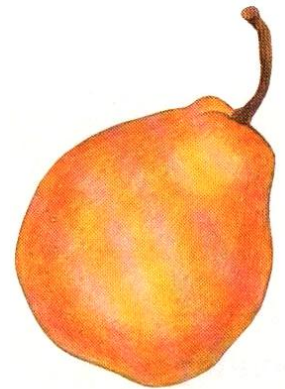

гру . а



лягу . ка

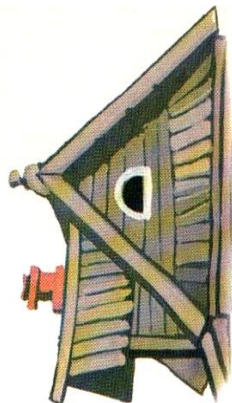

кры . а



слу . ает



о . ейник

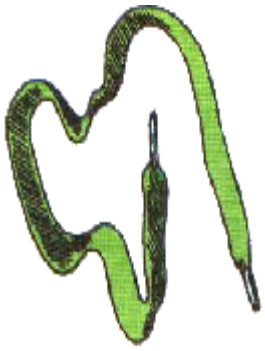

. нурок



КОКО . НИК

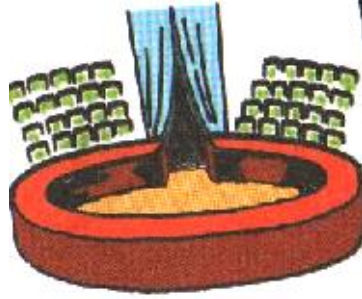

мане .



ме . КИ



игру . ки



ми . ка



п . еница



ка . аЛОТ